

Features & Benefits

- New generation IP65 LED panel, no glue, clean surface
- 120 lm/W high lumen efficacy, 80+ CRI
- TUV CB, CE and RoHS certified
- Lifud high efficiency LED driver, flicker free
- High efficiency LM80 SMD LEDs
- PMMA light guide panel
- ElecCoat™ technology provides white appearance, with superb heat dissipation performance
- NanoGap™ technology ensures the high lumen efficacy and protection of the LEDs
- Dimmable: DALI / 0-10V / TRIAC optional
- TpA fire-resistant PC diffuser optional
- 5 years warranty

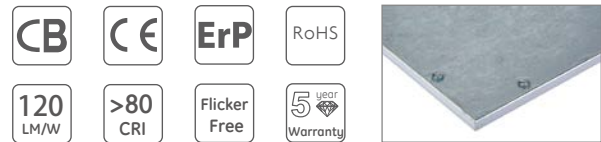

Technical Data

Input Voltage	*220-240VAC / 50/60 Hz
PF	*≥0.95@230VAC
THD	*≤20%
Driver Efficiency	*≥90%@230VAC
Life	50,000 hrs
Dimmable Control	DALI / 0-10V / Triac Optional
Frame Color	White
IP / IK / Glow-wire	IP65 / IK06 / 650 °C
Temperature / Humidity	Working: -20-40 °C Storage: <60 °C / <75%
UGR	<22

*LF-GIF040YA LED Driver

Specifications

	TLP-30120-36-120-IP65	TLP-30120-48-115-IP65
Rated Power (W) ±5%	36	48
Driver Output	33-40VDC / 850mA	33-40VDC / 1100mA
CCT (K)	6000 4000 3000	6000 4000 3000
LM Output (lm) ±5%	4320 4320 3960	5520 5520 4800
Lm/W ±5%	120 120 110	115 115 100
LED Type / Quantity	J200/14C16B 224pcs	
LM80 lumen maintenance	>98.8% @ 6,000hrs	
CRI / SDCM	>80 / <6	
Warranty	5 years	

Product Dimension

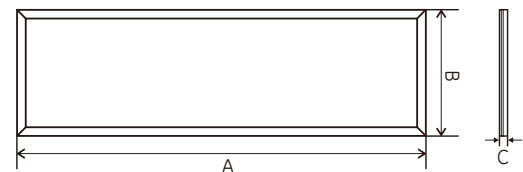

Type	Dimension		
	A	B	C
TLP-30120	1196	296	11

Ordering Information

Example : TLP-30120-36-NW-120

Model	Size	Wattage	Color Temp	Lm/W
TLP	30120 296*1196	26 26W	WW 3000K	115 120
		36 36W	NW 4000K	
			CW 6000K	

Photometric Data

TLP-3012-36-NW-120-IP65 36W 4000k

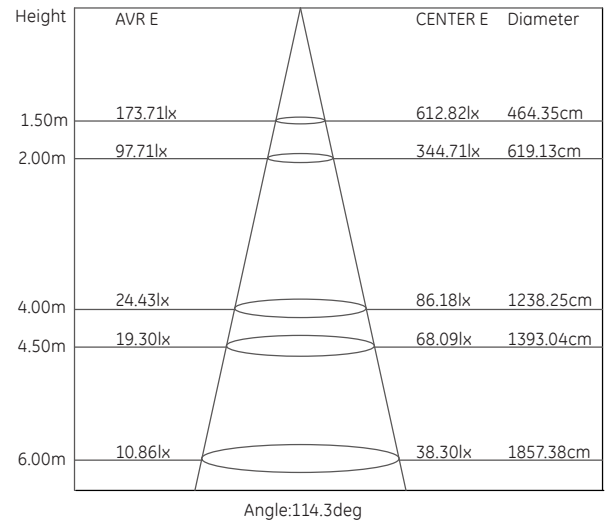
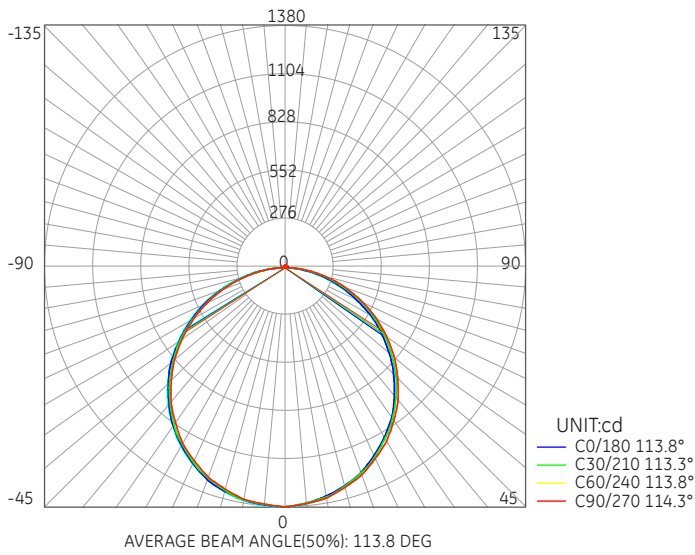

TLP-3012-48-NW-115-IP65 48W 4000k

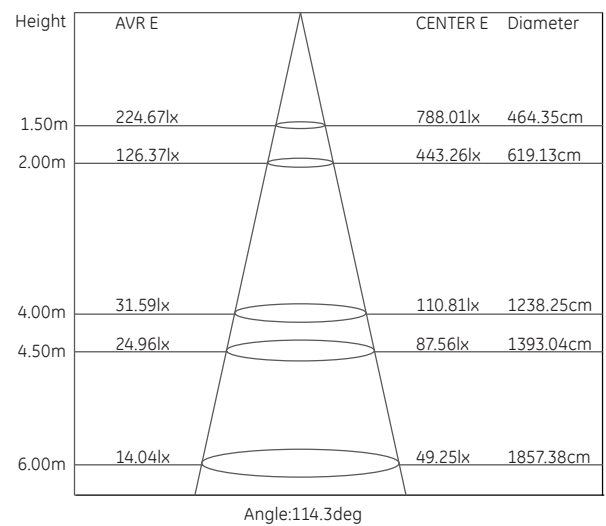
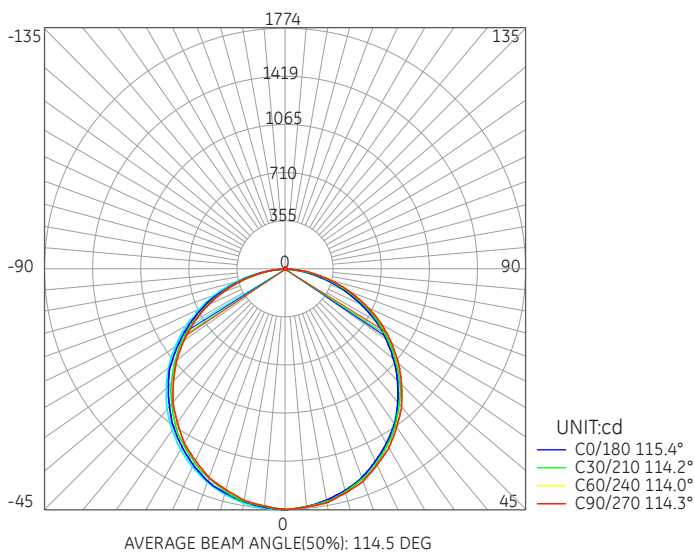

Packing Information

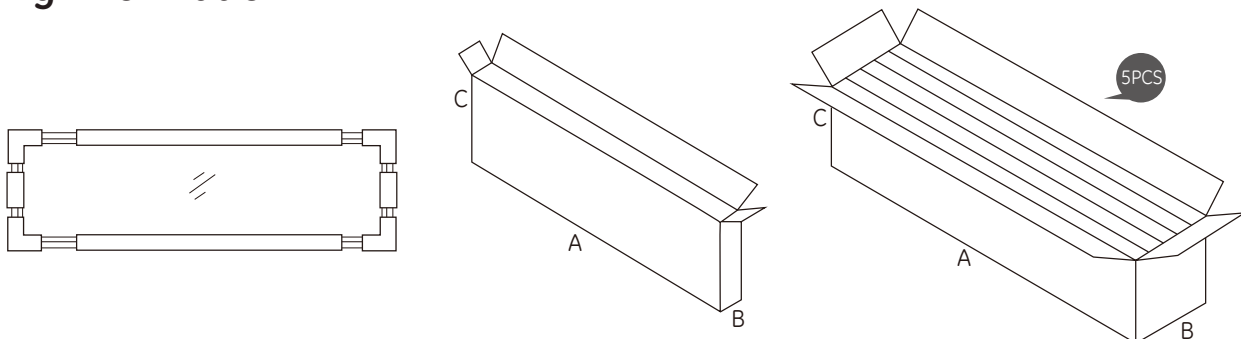

Panel	Box		Carton	
Model No.	ABC MAX (mm)	GW (kg)	ABC MAX (mm)	GW (kg)
TLP-3012-IP65	1290*35*350	4.9	1310*190*350	27