

Features & Benefits

- Special size LED panel: 150x1196 mm
- *90 lm/W high lumen efficacy, with high 80+ CRI
- TUV CB, GS, EMC and RoHS certified
- Philips Xitanium LED Driver, flicker free
- LM80 26x46mil 2835 SMD, 98.8% lumen maintenance @ 6,000 hours
- 3T PS LGP; 1.2T CHIMEI PS diffuser and TORAY frosted enhanced light reflector
- ElecCoat™ technology provides white appearance, with superb heat dissipation performance
- NanoGap™ technology ensures the high lumen efficacy and protection of the LEDs
- Dimmable: DALI / 0-10V / TRIAC optional
- 5 years warranty

* TLP-X-1512N/C-36



Specifications

	TLP-X-1512-36			TLP-X-1512-50		
Rated Power (W) ±5%	36			50		
Input Voltage / Frequency	220-240VAC 50/60Hz					
Driver Output	32-42VDC / 1050mA			33-40VDC / 1400mA		
PF	>0.9					
THD	<15%					
Efficiency	85%					
CCT (K)	6000	4000	3000	6000	4000	3000
LM Output (lm) ±5%	3240	3240	2952	4250	4250	3850
Lumen Efficacy (lm/W) ±5%	90	90	82	85	85	77
LED Type / Quantity	26x46mil Chip / 216pcs					
LM80	>98.8% lumen maintenance @ 6,000hrs					
CRI / SDCM	>80 / <3					
Warranty	5 years					
Life	50,000hrs					
Dimmable Control	DALI / 0~10V / Traic Optional					
Frame Color / RAL	Pure white / RAL9016					
Dimensions	150x1196x11mm					
Weight	2.2 Kg					
IP / IK / Glow-wire	IP20 / IK06 / 650 °C					
Temperature / Humidity	Working: -20 °C ~40 °C Storage: <60 °C / <75%					
UGR	< 22					

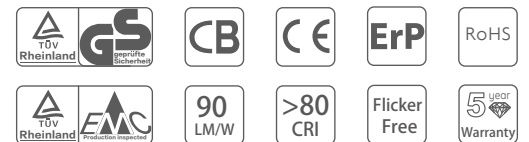

Product Dimension

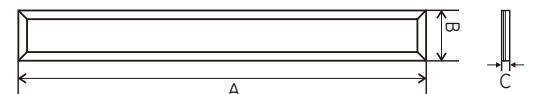

Type	Dimension		
	A	B	C
TLP-X-1512	1196	150	11

Ordering Information

Example : TLP-X-1512N-36

Model	Size	Color Temp	Wattage
TLP-X	1512 150*1196	W 3000K	36 36W
		N 4000K	
		C 6000K	50 50W

Photometric Data

TLP-X-1512N-36 36W 4000k

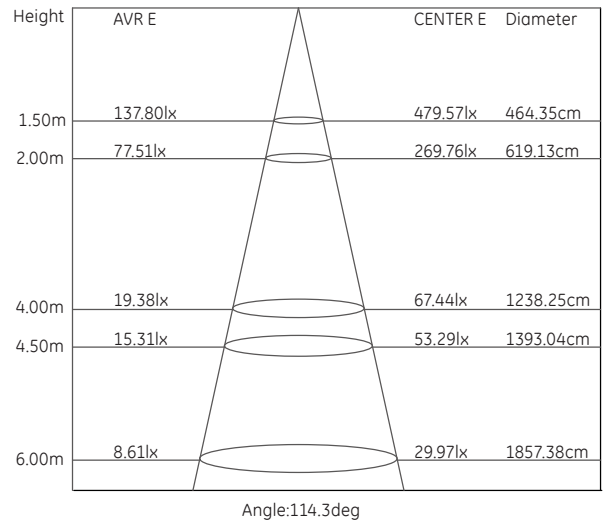
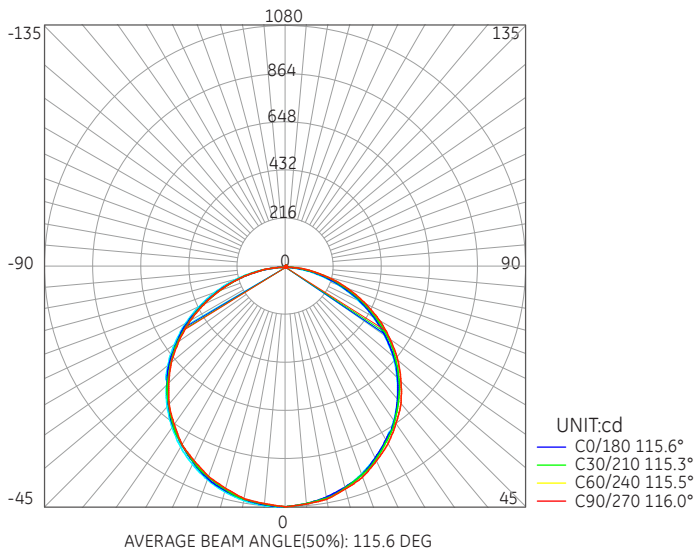

TLP-X-1512N-50 50W 4000k

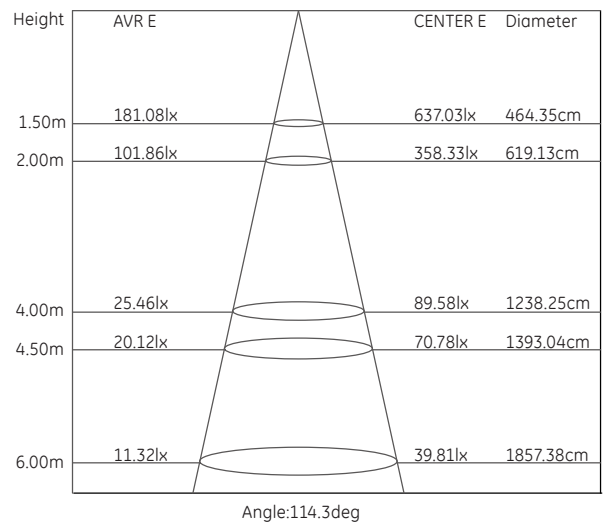
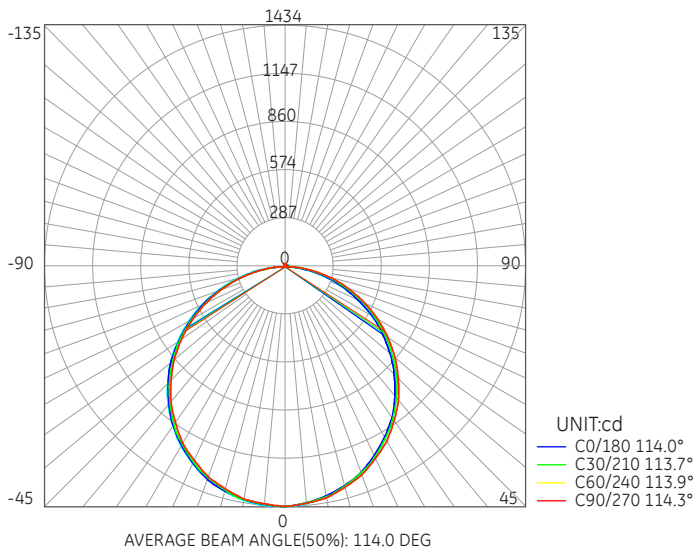

Packing Information

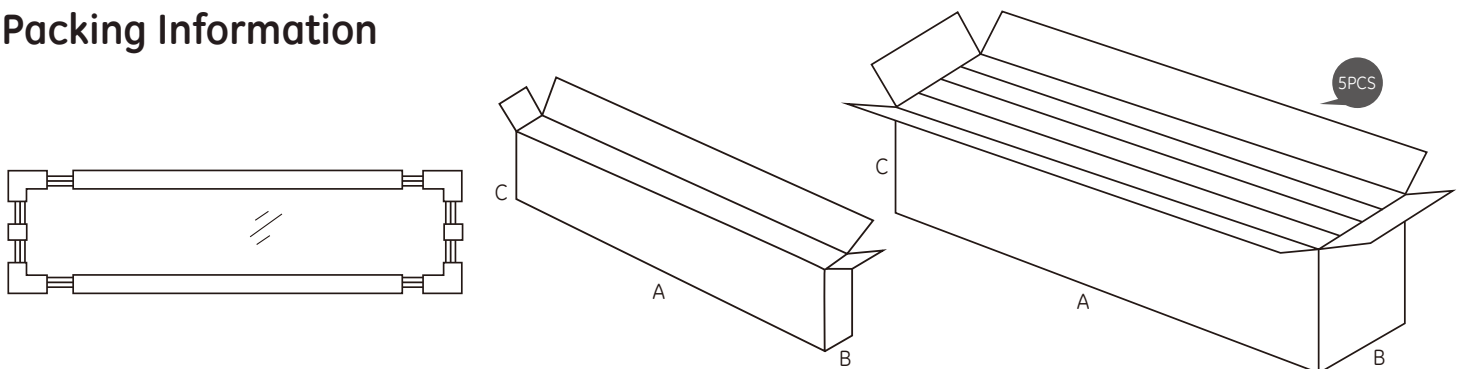

Panel	Box		Carton	
Model No.	ABC MAX (mm)	GW (kg)	ABC MAX (mm)	GW (kg)
TLP-X-1512	1290*35*200	2.45	1320*200*210	13.8