

90 lm/W 296 X 1196



### Features & Benefits

- \*90 lm/W high lumen efficacy, with high 80+ CRI.
- TUV CB, GS, EMC and RoHS certified.
- LM80 20x35mil 2835 SMD, 97.1% lumen maintenance @ 6,000 hours.
- 3T ENTIRE PS PMMA LGP, with extrusion process; 1.2T CHIMEI PS diffuser and DXC light reflector.
- ElecCoat™ technology provides white appearance, with superb heat dissipation performance.
- NanoGap™ technology ensures the high lumen efficacy and protection of the LEDs.
- Control: DALI / 0-10V / TRIAC dim control solutions available.
- Long life: L70 @ 80,000 hours.
- 5 years warranty.

\* TLP-F-3012N-40

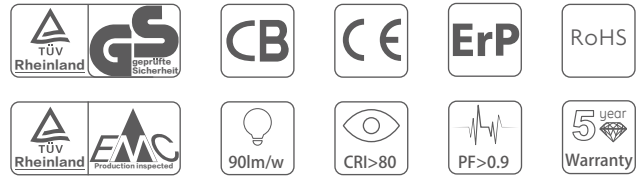

### Dimension

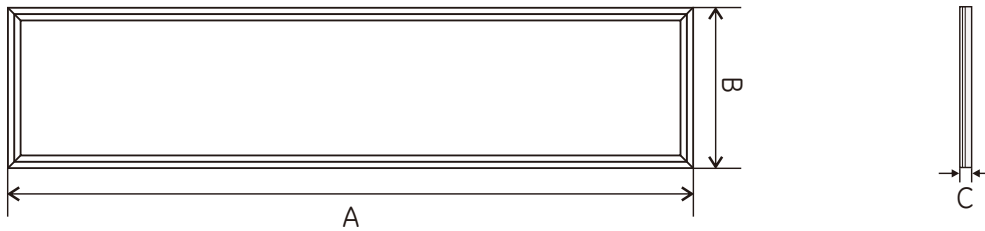

Model	Dimension (mm)		
	A	B	C
TLP-F-3012	1196	296	11

### Ordering Information

Example: TLP-F-3012N-40

Model	Size	Color Temp		Wattage	
		W	N	40	72
TLP-F	3012 296*1196	3000K			40W
		4000K			72W
		6000K			

### Specifications

#### Optical Parameters

	TLP-F-3012-40			TLP-F-3012-72		
Size	296x1196x11					
CCT	6000K	4000K	3000K	6000K	4000K	3000K
Lumen Output (lm) ±5%	3600	3600	3200	6120	6120	5508
LM Efficacy (lm/W) ±5%	90	90	80	85	85	76.5
LED Type / Quantity	20x35mil chip / 216pcs					
CRI / SDCM	>80 / <6					

#### Electrical Parameters

Rated Power ±5%	40W	72W
Rated / Actual Input	180-260VAC / 100-240VAC 50/60Hz	
Driver Output Data	25-38VDC / 1030mA / 36W	25-38VDC / 1800mA / 65W
Power Factor / THD / PE	>90% / <20 / 88%	
Driver / Connection	Removable Driver / PIP	
Over Load / Short Circuit	Protection	
Surge / Protection Class IEC	>1KV / Class II	
Hi-pot Test Range	SELV Isolated Driver, 3750Vdc / 5mA / 60S	

#### Life

Warranty	5 years
L70 Lifetime	80,000hrs
LM80	>97.1% lumen maintance @ 6,000hrs

#### Others

Dimmable Solution	DALI / 0-10V / TRIAC
Frame Color RAL	Pure white / RAL9016
IP / IK / Glow-wire	IP20 / IK06 / 650°C
Temperature / Humidity	Working: -20°C ~40°C Storage: <60°C / <75%

### Photometric Data

TLP-F-3012N-40 40W 4000k

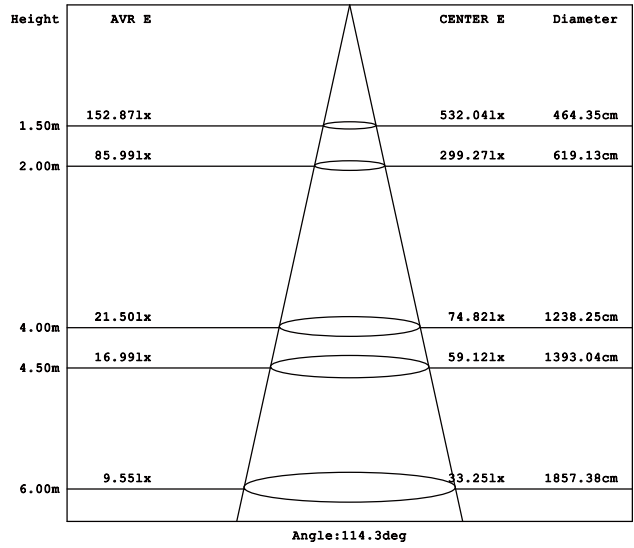
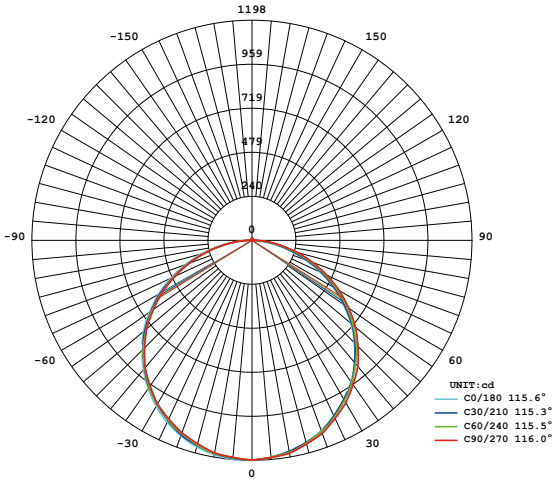

TLP-F-3012W-40 40W 3000k

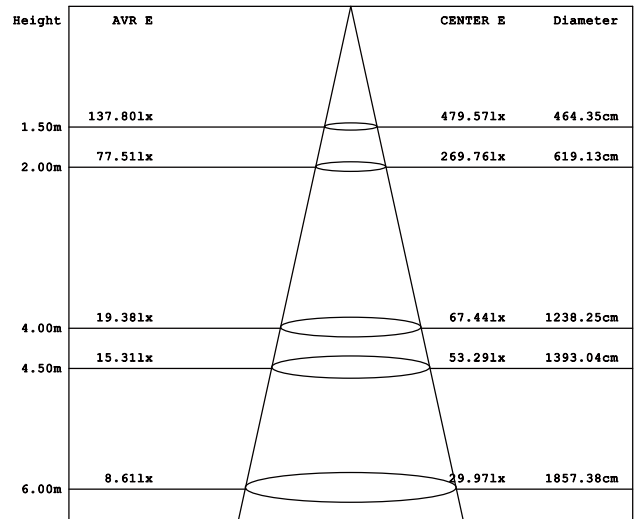
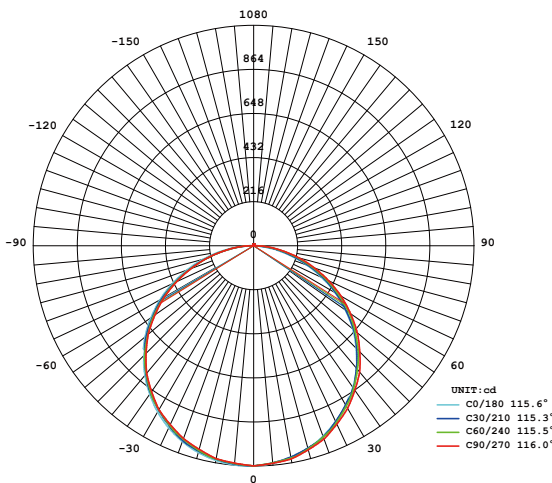

TLP-F-3012N-72 72W 4000k

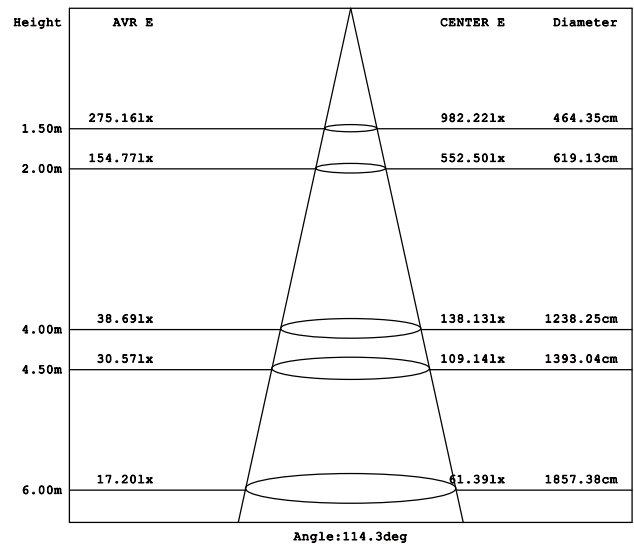
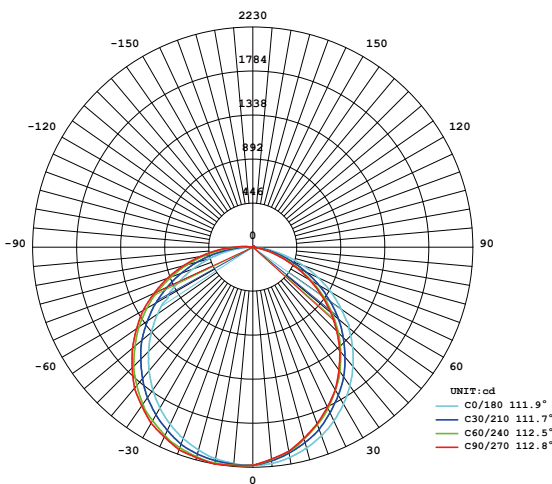

TLP-F-3012W-72 72W 3000k

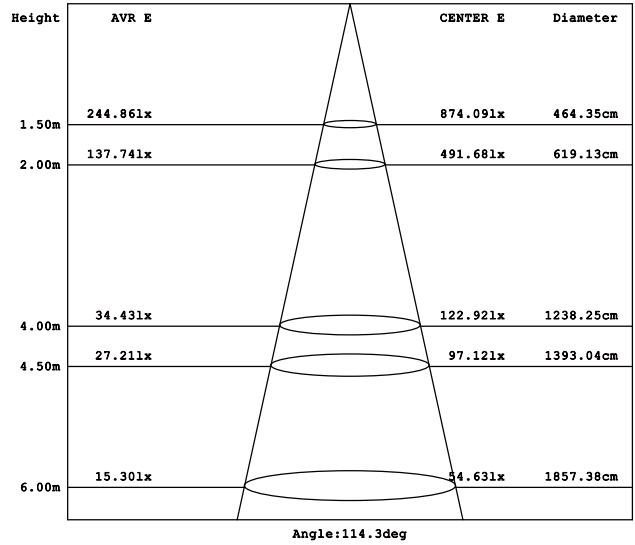
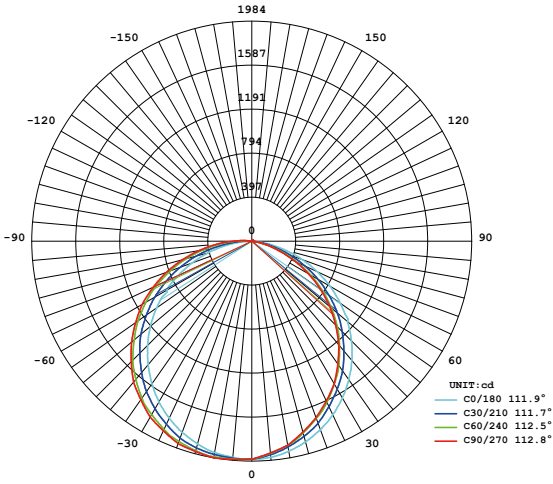

### Packing Information

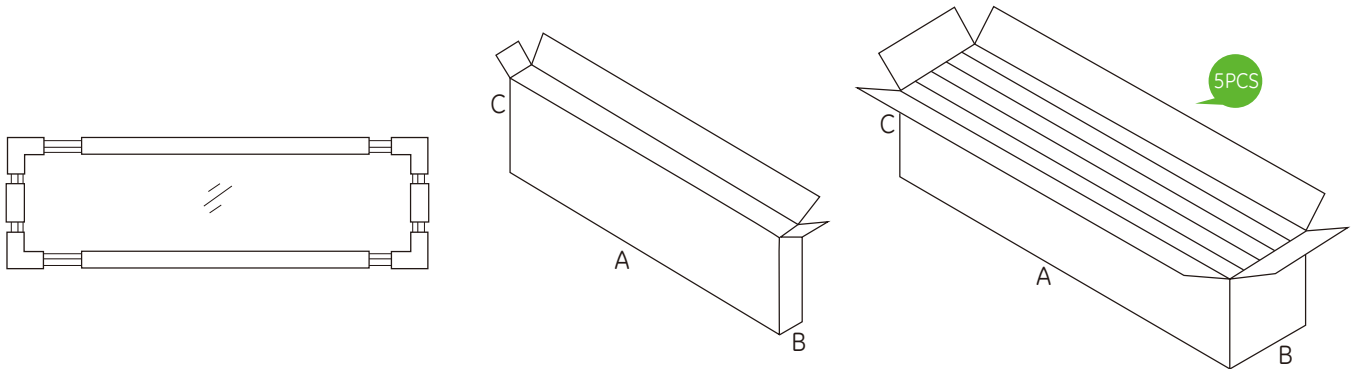

Panel	Box		Carton	
Model No.	ABC MAX (mm)	GW (kg)	ABC MAX (mm)	GW (kg)
TLP-F-3012	1250*45*350	4.45	1270*240*360	23